

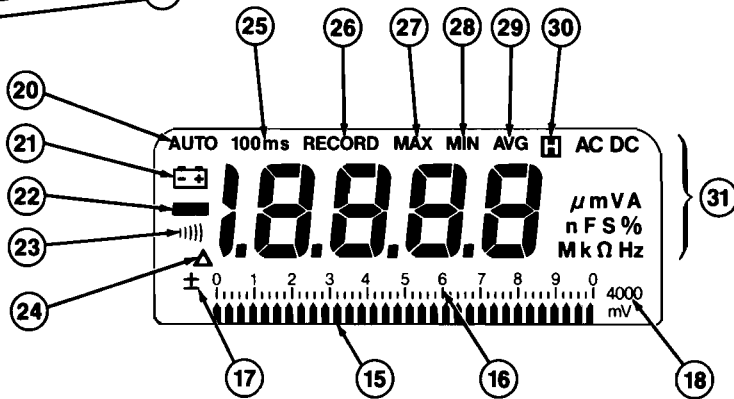

# 87 TRUE RMS MULTIMETER

USER'S MANUAL

**FLUKE**®

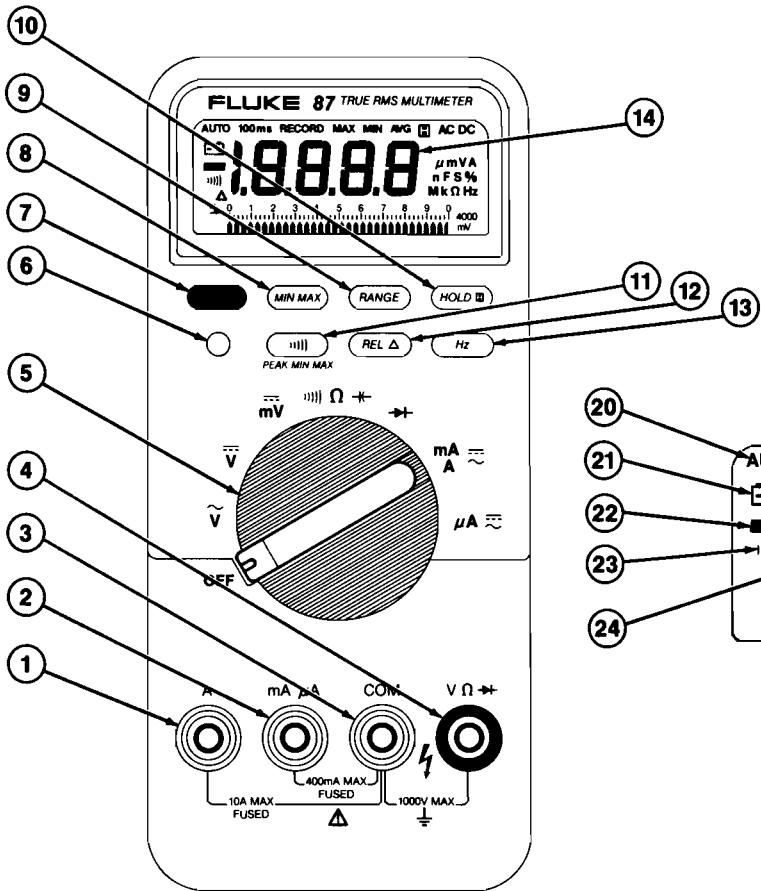

19

OL

---

# **87** *TRUE RMS MULTIMETER*

*USER'S MANUAL*

PN 834192  
August 1988 Rev.5, 1/93  
©1993 John Fluke Mfg. Co., Inc. All rights reserved. Litho in U.S.A

**FLUKE**®

## NOTICE

**The Fluke 87 generates and uses radio frequency energy. If it is not used according to the instructions in this manual, it may cause interference to radio and television reception. The Fluke 87 has been type tested and found to comply with the limits for a class B computing device in accordance with the specifications in Subpart J of Part 15 of FCC rules, which are designed to provide reasonable protection against such interference in a residential location. However, there is no guarantee that interference will not occur in a particular location. If this equipment does cause interference, which can be determined by turning the Fluke 87 off and on, the user is encouraged to try to correct the interference by one or more of the following measures:**

- **Move the Fluke 87 away from the receiver.**
- **If necessary, the user should consult the dealer or an experienced radio/television technician for additional suggestions.**

## CONTENTS

TITLE	PAGE
INTRODUCTION .....	1
MULTIMETER SAFETY .....	2
GETTING STARTED QUICKLY .....	3
HOW TO USE THE METER .....	4
Input Terminals and Input Alert .....	6
Function Selector Rotary Switch .....	6
Pushbuttons .....	8
Summary of Power-on Options .....	12
Digital and Analog Displays .....	13
Holster and Flex-Stand .....	17
APPLICATIONS .....	17
Measuring Voltage (AC/DC) .....	17
Measuring Current .....	17
Continuity Testing .....	19
Measuring Resistance .....	19
Using Conductance for High Resistance or Leakage Tests .....	20
Noisy Resistance Measurements .....	21

## CONTENTS, *continued*

TITLE	PAGE
Measuring Capacitance .....	21
Diode Testing .....	22
Using the Analog Bar Graph .....	23
Using the MIN MAX Recording Mode .....	23
Measuring Frequency .....	24
Measuring Duty Cycle .....	26
Pulse Width Measurements .....	27
MAINTENANCE .....	28
General Maintenance .....	28
Calibration .....	28
Battery Replacement .....	28
Fuse Test .....	30
Fuse Replacement .....	30
Service .....	31
REPLACEMENT PARTS .....	32
SPECIFICATIONS .....	34
SERVICE CENTERS .....	42

---

**INTRODUCTION****NOTE**

*This meter has been designed and tested according to IEC Publication 348, Safety Requirements for Electronic Measuring Apparatus. This manual contains information and warnings which must be followed to ensure safe operation and retain the meter in safe condition.*

**WARNING****READ "MULTIMETER SAFETY" BEFORE USING THE METER.**

The Fluke 87 True RMS Multimeter (also referred to as "the meter") is a handheld, 4000-count instrument that is designed for use in the field, laboratory, and at home. The meter combines the precision of a digital meter with the speed and versatility of a high resolution analog display. Frequencies between 0.5 Hz and 200 kHz can be measured with up to 0.01 Hz resolution. The meter is powered by a 9V battery and has a rugged case sealed against dirt, dust, and moisture. A snap-on holster, with flexible stand (Flex-Stand™), protects the meter from rough handling. The flexible stand allows the meter to be stood or hung.

The meter also provides:

- A MIN MAX Recording mode, in which the meter "remembers" the lowest and highest readings, calculates the true average of all readings taken over a period as long as thirty-six hours, and displays these values. The beeper emits a Min Max Alert™ when a new minimum or maximum reading is recorded.
- A Peak MIN MAX mode that captures changes as short as 1 millisecond.
- An alternate Frequency Counter mode that measures duty cycle and displays it as a value between 0.0 and 99.9%.
- An Input Alert™ that causes the beeper to sound if the test leads are plugged into the wrong input terminals for the function being performed.
- A REL mode that allows you to store a reading in memory, and display the difference between the stored value and subsequent readings.
- A Touch Hold® mode that allows you to keep your eyes fixed on the probes when taking measurements in difficult or hazardous circumstances, then read the display when it is convenient and safe.

## MULTIMETER SAFETY

- A display back-light that makes the meter useable in dark areas.
- A 4½-digit display mode for ten times increase in resolution.
- A Capacitance mode that measures capacitors from 0.01 nF to 5  $\mu$ F.

After unpacking the meter, if you notice that the meter is damaged or something is missing, contact the place of purchase immediately. Save the shipping container and packing material in case you have to reship the meter.

### MULTIMETER SAFETY

Before using the meter, read the following safety information carefully. In this manual the word, “**WARNING**,” is reserved for conditions and actions that pose hazard(s) to the user; the word, “**CAUTION**,” is reserved for conditions and actions that may damage your meter. The symbols shown in Figure 1 are used internationally to denote the electrical functions and conditions indicated. If the meter is not used as described in this manual, the safety features of the meter might be impaired.

- Avoid working alone.
- Do not allow the meter to be used if it is damaged, or its safety is impaired.

- Inspect the test leads for damaged insulation or exposed metal. Check test lead continuity. Damaged leads should be replaced.
- Be sure the meter is in good operating condition. During a continuity test, a meter reading that goes from overload (OL) to 0 generally means the meter is working properly.
- Select the proper function and range for your measurement.

### WARNING

**TO AVOID ELECTRICAL SHOCK, USE CAUTION WHEN WORKING ABOVE 60V DC OR 25V AC RMS. SUCH VOLTAGES POSE A SHOCK HAZARD.**









	DANGEROUS VOLTAGE		GROUND
	AC – ALTERNATING CURRENT		SEE EXPLANATION IN MANUAL
	DC – DIRECT CURRENT		DOUBLE INSULATION (Protection Class II)
	EITHER DC OR AC		FUSE

Figure 1. International Electrical Symbols



- Disconnect the live test lead before disconnecting the common test lead.
- Follow all safety procedures for equipment being tested. Disconnect the input power and discharge all high-voltage capacitors through a protective impedance before testing in the  $\Omega$  and  $\rightarrow$  functions.
- When making a current measurement, turn the power off before connecting the meter in the circuit.
- Check meter fuses before measuring current transformer secondary or motor winding current. (See "Fuse Test" in the "MAINTENANCE" Section.) An open fuse may allow high voltage build-up, which is potentially hazardous.

### GETTING STARTED QUICKLY

Examine the meter carefully, familiarizing yourself with the layout of the input terminals, rotary switch, pushbuttons and display. Notice the WARNING information and summary of power-on options engraved into the rear panel.

If you have used a multimeter before, simply examining your meter will probably give you a good idea how to use it. The following procedure is an overview of how to take basic measurements.

### WARNING

**TO AVOID ELECTRICAL SHOCK OR DAMAGE TO THE METER, DO NOT APPLY MORE THAN 100V BETWEEN ANY TERMINAL AND EARTH GROUND.**

1. Insert the test leads in the appropriate input terminals (see Table 1). If the test leads are in the wrong input terminals when the meter is turned on and the beeper has not been disabled, the beeper will emit a warning. See "Input Terminals and Input Alert", below.
2. To turn the meter on and select a function, turn the rotary switch from OFF to the appropriate switch position. All segments on the liquid-crystal display (LCD) will turn on for one second, then the meter is ready for normal operation. If you would like to freeze the display with all segments on, press and hold down any button, while turning the meter on. As long as the button is held down, all LCD segments will remain on.
3. To select an additional operation, press the appropriate pushbuttons above the rotary switch as described in the items below. (See also, Figure 2)

## HOW TO USE THE METER

---

- To operate the MIN MAX and RANGE buttons: press to select, press again to scroll or increment, and press and hold for two seconds to exit.
- To operate the Hz button: press to select the frequency mode, press again to select duty cycle, and press again to exit.
- To operate the back-lit display, press the YELLOW button. The back-light automatically turns off in 68 seconds to conserve battery life.
- To operate the remaining buttons: press to select and press again to exit.

### NOTE

*The response of the display and the pushbuttons slows down in the capacitance mode.*

An annunciator is displayed when a mode has been selected. A quick way to reset all the pushbuttons to their default state is to turn the rotary switch to an adjacent function and then back to the function you are using.

4. To take a measurement, use the test lead probes to make the proper contacts. Remember, insert the meter in the circuit in parallel for voltage and in series for current

measurements. Read the measurement on the display. If you did not manually select a range (by using the RANGE button), the range that provides the best resolution is automatically selected.

5. To run a performance check of the meter, turn the rotary switch to  $\Omega$  and connect a test lead from the  $V\Omega$  input to the mA  $\mu$ A input. (If you are using a test probe, touch the half of the input contact nearest the LCD.) The display should read  $1.000\text{ k}\Omega \pm 5$  digits. With the rotary switch still at  $\Omega$ , test the A fuse (15A) by inserting the plug end of the test lead into the A input and test the mA  $\mu$ A fuse (1A) by inserting the plug end of the test lead into the mA  $\mu$ A input. The beeper emits an Input Alert if the fuses are good.

Although this procedure will allow you to get started quickly, we suggest that you take the time to read the remainder of this manual so that you can learn to take full advantage of your meter's capabilities.

## HOW TO USE THE METER

This section describes your meter and how to use it. **FOR EASE OF REFERENCE, EACH DESCRIPTION IS NUMBERED AND KEYED TO THE ILLUSTRATION INSIDE THE FRONT COVER.**

**HOW TO USE THE METER**  
Input Terminals

**Table 1. Input Terminals and Limits**

FUNCTION	INPUT TERMINALS		MIN DISPLAY READING	MAX DISPLAY READING	MAXIMUM INPUT
	Red Lead	Black Lead			
$\tilde{V}$	V $\Omega$ $\leftrightarrow$	COM	0.1 mV	1000V	1000V
$\bar{V}$	V $\Omega$ $\leftrightarrow$	COM	0.0001V	1000V	1000V
$\bar{mV}$	V $\Omega$ $\leftrightarrow$	COM	0.01 mV	400.0 mV	1000V
$\Omega$	V $\Omega$ $\leftrightarrow$	COM	0.01 $\Omega$	40.00 M $\Omega$	1000V †
nS	V $\Omega$ $\leftrightarrow$	COM	0.001 nS	40.00 nS	1000V †
$\dashv$	V $\Omega$ $\leftrightarrow$	COM	0.01 nF	5.00 $\mu$ F	1000V †
$\leftrightarrow$	V $\Omega$ $\leftrightarrow$	COM	0.0001V	3.000V	1000V †
A $\bar{\sim}$	A	COM	1 mA	20.00A*	15A 600V FAST Fuse**
mA $\bar{\sim}$ $\mu$ A $\bar{\sim}$	mA/ $\mu$ A mA/ $\mu$ A	COM COM	0.01 mA 0.1 $\mu$ A	400.0 mA 4000 $\mu$ A	1A 600V FAST Fuse**

\* 10A continuous, 20A for 30 seconds maximum.      \*\* Fuse protected.      † For circuits < 0.3A short circuit, 660V for high energy circuits.

## HOW TO USE THE METER

### Input Terminals and Function Selector Rotary Switch

#### Input Terminals and Input Alert

Items 1-4 describe the input terminals. (See Table 1 for overload limits.) If the test leads are connected to the Amperes input terminal, and the function selector switch is not in the Amp measurement position, the beeper will emit an Input Alert. An Input Alert will also sound if the test leads are connected to the mA  $\mu$ A terminal and the function switch is not in either Amp position. After an Input Alert sounds, the meter will attempt to take a reading from inputs applied to the  $V\Omega \rightarrow$  terminal. Input Alert can be disabled by pressing  while turning the rotary switch from OFF to any function position.

① **A Amperes Input Terminal**

For current measurements (ac or dc) up to 10A continuous (20A for 30 seconds) when function selector switch set to  $\frac{mA}{A} \sim$ .

② **mA  $\mu$ A Milliamp/Microamp Input Terminal**

For current measurements up to 400 mA (ac or dc) when the function selector switch is set to  $\frac{mA}{A} \sim$  or  $\mu A \sim$ .

③ **COM Common Terminal**

Return terminal for all measurements.

④  **$V\Omega \rightarrow$  Volt, Ohms, Diode Test Input Terminal**

#### Function Selector Rotary Switch

⑤ Item 5 describes functions that are selected by setting the rotary switch. Each time the rotary switch is moved from OFF to a function setting, all LCD segments will turn on for one second as part of a selftest routine. (This selftest routine is also performed if the rotary switch is turned slowly from one position to another.) The meter is then ready for normal operations and will respond to the rotary switch and pushbuttons.

#### OFF

Power to the meter is turned off.

$\sim$   
**V Volts ac**

Autoranges to the 400 mV, 4V, 40V, 400V or 1000V range.

## HOW TO USE THE METER Function Selector Rotary Switch

 **Volts dc**

Autoranges to the 4V, 40V, 400V or 1000V range.

 **Millivolts dc**

Single 400 mV range.

 **Resistance ( $\Omega$ ), conductance ( $1/\Omega$ ), capacitance or continuity testing**

Press BLUE button to toggle between the resistance and capacitance function. (The response of the display and the pushbuttons slows down in the capacitance mode.)

Autoranges to the 400 $\Omega$ , 4 k $\Omega$ , 40 k $\Omega$ , 400 k $\Omega$ , 4 M $\Omega$ , or 40 M $\Omega$  resistance range.

In Manual Ranging mode, 40 nS conductance range (equal to a 25-100,000 M $\Omega$  range) is selectable. (See item 9.)

Autoranges to the 05.00 nF, .0500  $\mu$ F, 0.500  $\mu$ F, and 05.00  $\mu$ F capacitance range.

When testing continuity, the beeper sounds if the resistance falls below the typical values indicated in Table 2.

**Table 2. Beeper Responses in Continuity Test**

Input Range	Beeper On If
400.0 $\Omega$	< 40 $\Omega$
4.000 k $\Omega$	< 200 $\Omega$
40.00 k $\Omega$	< 2 k $\Omega$
400.0 k $\Omega$	< 20 k $\Omega$
4.000 M $\Omega$	< 200 k $\Omega$
40.00 M $\Omega$	< 200 k $\Omega$

 **Diode Test**

Measures forward voltage of semiconductor junction(s) at approximately 1 mA test current. Single 0-3V range.

  
 **Milliamps or amperes**

Defaults to dc. Press BLUE button to toggle between dc and ac.

Autoranges to the 40 mA or 400 mA range when using the mA  $\mu$ A input terminal, or to the 4000 mA or 10A range when using the A input terminal.

## HOW TO USE THE METER

### Pushbuttons

#### $\mu\text{A}$ Microamps.

Defaults to dc. Press BLUE button to toggle between dc and ac.

Autoranges to the 400  $\mu\text{A}$  or 4000  $\mu\text{A}$  range when using the mA  $\mu\text{A}$  input terminal.

### Pushbuttons

Items 6-13 describe how to use the pushbuttons. These buttons are used (in conjunction with rotary switch) to select operating modes and set power-on options. When a button is pushed the beeper sounds (unless the beeper has been turned off or the Data Output mode has been selected). A summary of pushbutton operations is shown in Figure 2. An annunciator is displayed to indicate that a mode or option has been selected. A quick way to reset all the pushbuttons to their default state is to turn the rotary switch to an adjacent function and then back to the function you are using.

#### 6 Display Back-Light

Press the YELLOW button to turn on the back-light. Back-light turns off automatically after 68 seconds to extend battery life.

#### Power-On Option: 4½-Digit Display Mode

The meter displays the readings at 10 times the resolution with a maximum display at 19,999 counts. The display is updated once per second. The 4-½ digit display mode works in all functions except capacitance, Peak MIN MAX and 100 millisecond MIN MAX.

#### 7

#### AC or DC, Resistance or Capacitance

Press BLUE button to toggle between ac and dc when measuring current, or between capacitance and resistance when the rotary switch is set to  $\Omega$   $\text{F}$ .

#### Power-On Option: Disable Automatic Power-off

Automatic Power-off extends the life of the battery by turning the meter off if neither the rotary switch nor a pushbutton is operated for half an hour. (Automatic Power-off is not allowed in the MIN MAX Recording or Data Output modes.) The meter turns back on if either the rotary switch is turned or a pushbutton is pressed.

#### 8

MIN MAX

#### Minimum (MIN), Maximum (MAX), Average (AVG) Recording

Press  to enter the MIN MAX Recording mode (manual range only). Select the proper range before selecting MIN MAX to ensure that the min max reading will not exceed the measurement range. The minimum, maximum, and average values are then reset to the present input; the RECORD annunciator turns on; the AUTO annunciator turns off; and the automatic power-off feature is disabled.

In the MIN MAX Recording mode, the minimum and maximum readings are stored in memory. The beeper emits a tone when a new minimum or maximum value is recorded. A continuous beeper

## HOW TO USE THE METER Pushbuttons

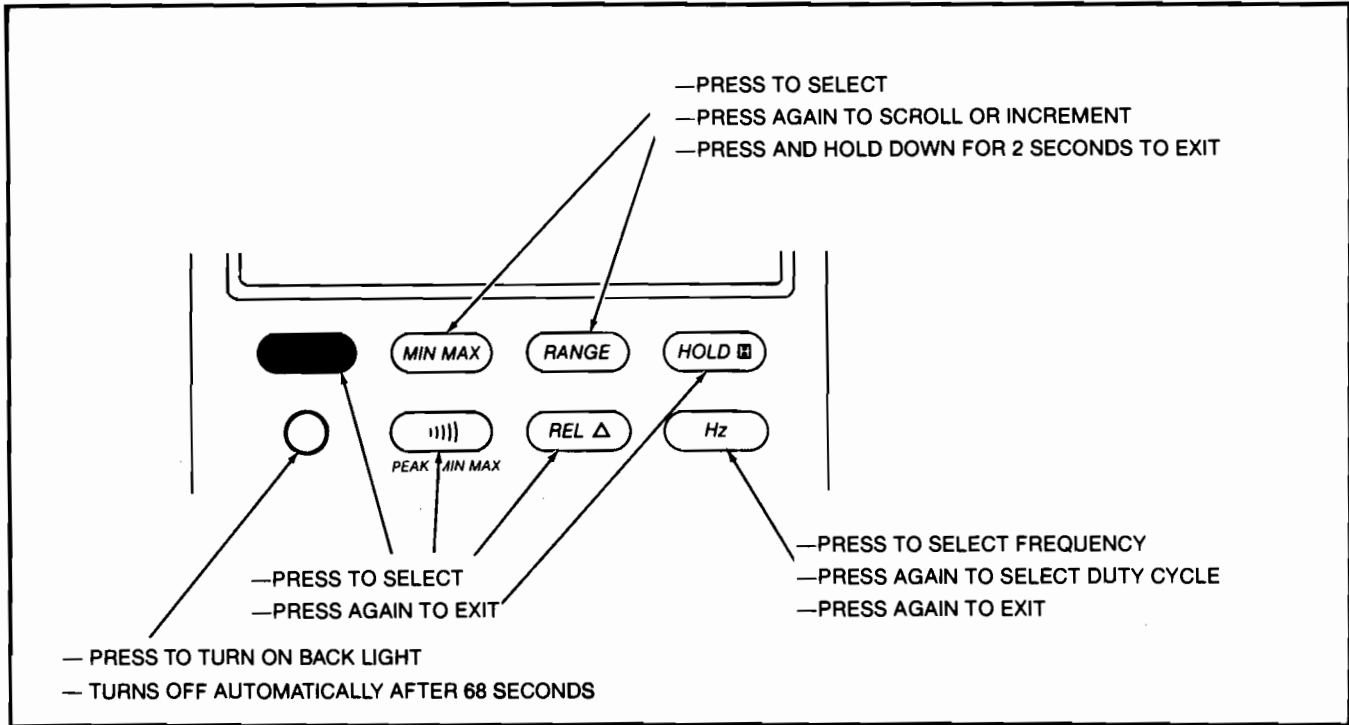



Figure 2. Summary of Pushbutton Operations

## HOW TO USE THE METER

### Pushbuttons



---

tone is emitted when an overload is recorded. Push  to cycle through the maximum (MAX), minimum (MIN), average (AVG), and present readings. The MIN, MAX, or AVG annunciator turns on to indicate what value is being displayed. If an overload is recorded, the averaging function is stopped and the average value becomes OL (overload).

The true average of all the readings taken over at least a thirty-six hour period can be displayed. If this duration is exceeded, the actual minimum and maximum readings will continue to be captured and can be displayed. However, new averages are no longer calculated. The last average calculated is retained as the average reading.

At normal (default) record speed, changes to the voltage, current, or resistance inputs that last at least 100 milliseconds are recorded, and the "100 ms" annunciator turns on. Press and hold down the  for 2 seconds to exit and erase recorded readings.

In the MIN MAX mode, press  to select the Peak MIN MAX mode ("1 ms", "RECORD", and "MAX" are displayed). Voltage or current inputs that last for 1 milliseconds or longer are captured. Press

 to select the minimum (MIN) reading. Press again to return to the maximum (MAX) reading. To reset the Peak MIN MAX mode press  twice: the first press exits the mode, and the second press re-enters the mode. To completely exit the MIN MAX mode, press  for one second. In Peak MIN MAX mode, the present reading, average (AVG) readings, and analog display are not displayed. Before selecting Peak MIN MAX, select DC voltage or current to DC couple the input waveform; or AC voltage to capacitively couple the input waveform. Peak MIN MAX works in all functions except ohms, frequency and capacitance.

In the MIN MAX Recording mode, press  to stop the recording of readings; press again to restart recording. If recording is stopped, the minimum, maximum, average, and present values are frozen, but the analog display continues to be active. When recording is stopped, the stored readings are not erased and you can still scroll through these readings.

#### **Power-On Option: Select High Accuracy MIN MAX Recording**

The High Accuracy MIN MAX Recording mode has a response time of approximately 1 second. Changes of more than 1 second duration are recorded. The "1 s" annunciator is turned on. In the Frequency Counter mode, readings are always recorded at the high accuracy recording speed; the response time is not selectable.



9

**RANGE** Manual Ranging

Press **RANGE** to select the Manual Range mode and turn off the AUTO annunciator. (The meter remains in the range it was in when manual ranging was selected.)

In the Manual Range mode, each time you press **RANGE** button, the range (and the input range annunciator) increments, and a new value is displayed. If you are already in the highest range, the meter “wraps around” to the lowest range. (In the Frequency Counter mode, pressing **RANGE** manually selects the input voltage or current range.) To exit the Manual Range mode and return to auto-ranging, Press and hold down **RANGE** for 2 seconds. The AUTO annunciator turns back on.

When the range is changed manually, the Touch Hold, MIN MAX Recording, and REL[at]ive modes are disabled.

**Power-On Option: Rotary Switch Test**

The Rotary Switch Test is used only for servicing purposes. See the 80 Series Service Manual for details. In the Rotary Switch Test mode, normal meter functions are disabled. To exit the Rotary Switch mode, turn the rotary switch to OFF and back to any switch setting.

10

**HOLD** Display Hold

**WARNING**

**TOUCH HOLD WILL NOT CAPTURE UNSTABLE OR NOISY READINGS. DO NOT USE TOUCH HOLD TO DETERMINE THAT CIRCUITS WITH DANGEROUS VOLTAGE ARE DEAD.**

Press **HOLD** to toggle in and out of the Touch Hold mode, except if you are already in the MIN MAX Recording or Frequency Counter mode.

In the Touch Hold mode, the **H** annunciator is displayed and the last reading is held on the display. When a new, stable reading is detected, the beeper emits a tone, and the display is automatically updated. Pressing **MIN MAX** when you are in the Touch Hold mode causes you to exit Touch Hold and enter the MIN MAX Recording mode.

In the MIN MAX Recording mode, press **HOLD** to stop the recording of readings; press **HOLD** again to resume recording. (Previously recorded readings are not erased.)

In the Frequency Counter mode (Hz), press **HOLD** to stop the display; press **HOLD** again to start it.

## HOW TO USE THE METER

### Pushbuttons

11

#### Continuity Beeper/Peak MIN MAX

Press to toggle the beeper on or off for continuity testing in the ohms function.

The beeper responds as indicated in Table 2.

In the Frequency Counter mode, press to change the trigger slope from positive-going edges to negative-going edges. The slope selected is indicated by the analog display polarity annunciator ( $\pm$ ).

In the MIN MAX mode, press to toggle in and out of the Peak MIN MAX mode. See item 8.

#### Power-On Option: Disable Beeper

When the beeper has been disabled, all beeper functions are turned off. The beeper is automatically disabled if the meter is in the Data Output mode.

12

#### Relative Readings

Press to enter the Relative mode, zero the display, and store the displayed reading as a reference value. The relative mode annunciator ( $\Delta$ ) is displayed. Press again to exit the relative mode.

In the Relative mode, the value shown on the LCD is always the difference between the stored reference

value and the present reading. For example, if the reference value is 15.00V and the present reading is 14.10V, the display will indicate -0.90V. If the new reading is the same as the reference value, the display will be zero.

13

#### Frequency Counter Mode and Duty Cycle

Press the to select the Frequency Counter mode; press again to select duty cycle (the alternate counter function); press again to exit. The analog display does not operate in either the Frequency Counter mode or duty cycle.

In Frequency Counter mode, the Hz annunciator is displayed. The frequency function autoranges over five ranges: 199.99 Hz, 1999.9 Hz, 19.999 kHz, 199.99 kHz, and greater than 200 kHz. The RANGE button manually selects the voltage or current input range. If duty cycle is selected, readings from 0.0 through 99.9 are displayed. The "Hz" annunciator turns off and "%" turns on.

#### Power-On Option: High Input Impedance Mode

The input impedance of the  $\overline{mV}$  function (400 mV range) is changed from 10 megohms to greater than 4000 megohms.

### Summary of Power-on Options

You can select a number of options each time you turn the meter on. These power-on options (also listed on the rear of

the meter) are selected by holding down one or more of the pushbuttons while turning the function switch to any ON position. All power-on options are only disabled when the rotary switch is turned to OFF. Each power-on option is discussed in detail under "Pushbuttons" and summarized in Table 3.

**Digital and Analog Display**

Items 14-19 describe the digital and analog displays and LCD annunciators.

14

**Digital Display**

Digital readings are displayed on a 4000-count display with polarity ( $\pm$ ) indication and automatic decimal point placement. When the meter is turned on, all display segments and annunciators appear briefly during a selftest. The display updates four times per second, except when frequency readings are taken. Then the update rate is 3 per second.

**Table 3. Options Available at Power-on**

OPTION	PUSHBUTTON	FUNCTION
Automatic Power-off	BLUE	Disable Automatic Power-off
4½ Digit Mode	YELLOW	Select 4½ digit display. Full scale 19,000 counts.
MIN MAX Record Speed	MIN MAX	Select High Accuracy record speed. (Response time approximately 1 second)
Rotary Switch Test	RANGE	For servicing purposes only. See 80 Series Service Manual
Data Output	HOLD H	Enable ultrasonic data transmission. (For use in factory testing only, cannot be modified for customer use. Beeper functions disabled.)
Disable Beeper	)	Turns off all beeper functions
High Input Impedance in mV DC	Hz	Provides >4000 M $\Omega$ input impedance for 400 mV dc range

## HOW TO USE THE METER

### Digital and Analog Displays

15



#### Analog Display

The analog display is a 32-segment pointer that updates at a 40 times per second rate and is the best display to use for readings that are changing. It does not operate in the Capacitance or Frequency Counter functions or in the Peak MIN MAX mode.

For increased sensitivity, the analog pointer moves across the scale four times for each range. The pointer returns to 0 (wraps around) when the equivalent digital display reaches 1024, 2048, and 3072 counts. Select the next higher range if the pointer is too sensitive.

The analog pointer indicates a value lower than the digital display (up to 2.5% of range). Examples on the 40V range are:

Digital Display	= 5.00V	15.00V	25.00V	35.00V
Analog Pointer	= 4.8	4.5	4.5	4.2
Wrap	= First	Second	Third	Fourth
Indication	= 4.8V	14.5V	24.5V	34.2V

16

With stable inputs, use the digital display for the best sensitivity and precision.

#### 0 1 2 3 4 5 6 7 8 9 0 Analog Display Scale

Scale for each 1000 counts in the digital display.

17

± Analog Display Polarity

Indicates the polarity of the input except in the Frequency Counter mode, when it indicates the polarity of the trigger slope (edge).

18

#### 4000 mV Input Range Annunciator





Displays 4, 40, 400, or 4,000 input range for volts, amps, or ohms, and 400 mV.

19

#### OL Overload Indication

Displayed on digital display when input (or math calculation in REL mode) is too large to display. If you are taking duty cycle readings, OL is displayed if the input signal stays high or low. All segments are illuminated on analog display.

Items 20-23 describe annunciators that indicate the mode or state in which the meter is operating:

- ⑳ **AUTO**     **Autorange**
- Meter is in the autorange mode and will automatically select the range with the best resolution. Meter powers-on in autorange mode.
- In the autorange mode, the meter ranges up at 4096 counts and ranges down at 360. When the meter is in the Manual Range mode, the overrange arrow is displayed until you manually select a range appropriate for the input value.
- See item 9 for manual ranging.
- ㉑      **Low Battery**
- Meter is powered by a single 9V battery, with a typical life of 400 hours with an alkaline battery. At least 8 hours of battery life remain when  is first displayed. A battery check is taken between measurements.
- ㉒      **Negative Polarity**
- Automatically indicates negative inputs. When REL is enabled, indicates negative results of math calculations.
- ㉓      **Beeper**
- Continuity test is enabled. See item 11 and Table 2.
- Items 24 through 31 describe math function annunciators and the annunciators that indicate the units of the value displayed.
- ㉔      **Relative Mode**
- The value displayed is the difference between the present measurement and the previously stored reading. See item 12.
- ㉕ **100 ms**     **Normal Recording Speed in MIN MAX Recording Mode**
- Input changes of 100 milliseconds or longer will be recorded. In the 1 s High Accuracy MIN MAX Recording Mode, the recording speed is 1 second.
- 1 ms**     **Peak MIN MAX Recording Mode**
- Input changes of 1 millisecond or longer will be recorded.

## HOW TO USE THE METER

### Annunciators

**26**      **RECORD**      **Minimum, Maximum, and Average Recording**

Readings are being recorded in the MIN MAX Recording mode. A maximum (MAX), minimum (MIN), or average (AVG) reading can be displayed.

**27**      **MAX**              **Maximum Value in MIN MAX Recording Mode**

The value displayed is the maximum reading taken since the MIN MAX Recording mode was entered.

**28**      **MIN**              **Minimum Value in MIN MAX Recording Mode**

The value displayed is the minimum reading taken since the MIN MAX Recording mode was entered.

**29**      **AVG**              **Average Value in MIN MAX Recording Mode**

The value displayed is the true average of all readings taken since the MIN MAX Recording mode was entered.

**30**            **Hold**

The meter is operating in a Display Hold mode. See item 10 for Display Holds.

**31**      The following annunciators indicate the unit of the value displayed:

- AC** Alternating current or voltage
- DC** Direct current or voltage
- V** Volts
- mV** Millivolts ( $1 \times 10^{-3}$  volts)
- A** Ampere (amps). Current
- mA** Milliampere ( $1 \times 10^{-3}$  amps)
- $\mu$ A** Microampere ( $1 \times 10^{-6}$  amps)
- nS** Nanosiemens ( $1 \times 10^{-9}$  siemens).  
Conductance (1/ohms).
- %** Percent Annunciator (for duty cycle readings only)
- $\Omega$**  Ohms. Resistance
- k $\Omega$**  Kilohm ( $1 \times 10^3$  ohms). Resistance
- M $\Omega$**  Megohm ( $1 \times 10^6$  ohms). Resistance
- Hz** Hertz (1 cycle/sec). Frequency
- kHz** Kilohertz ( $1 \times 10^3$  cycles/sec). Frequency
- $\mu$ F** Microfarads ( $1 \times 10^{-6}$  Farads). Capacitance
- nF** Nanofarads ( $1 \times 10^{-9}$  Farads). Capacitance

**32**            **Not Used**  
**Duty**      **Not Used**

### **Holster and Flex-Stand**

The meter comes with a snap-on holster that absorbs shocks and protects the meter from rough handling. The holster is equipped with a Flex-Stand. Some uses of the holster with Flex-Stand are shown in Figure 3.

### **APPLICATIONS**

This section discusses some common applications for your meter, and alerts you to some considerations to keep in mind when taking measurements.

#### **Measuring Voltage (AC/DC)**

To measure voltage, connect the meter in parallel with the load or circuit under test. Each of the five ac/dc voltage ranges presents an input impedance of approximately 10 M $\Omega$  in parallel with less than 100 pF. Ac voltage is ac-coupled to the 10 M $\Omega$  input.

To improve the accuracy of dc voltage measurements made in the presence of ac voltages, measure the ac voltage first. Note the ac voltage range and manually select a dc voltage range that is the same or higher than the ac voltage range. This method improves the dc voltage accuracy by ensuring that the

input protection circuits are not being activated. A typical application is measuring the dc offset voltage of an amplifier in the presence of an ac signal.

Measurement errors due to circuit loading can result when making either ac or dc voltage measurements on circuits with high source impedance. In most cases, the error is negligible (0.1% or less) if the measurement circuit source impedance is 10 kilohms or less.

#### **Measuring Current**

#### **WARNING**

**DO NOT ATTEMPT AN IN-CIRCUIT CURRENT MEASUREMENT WHERE THE POTENTIAL IS GREATER THAN 600V. YOU MAY DAMAGE THE METER OR BE INJURED IF THE FUSE BLOWS WHILE CURRENT IS BEING MEASURED IN A CIRCUIT WHICH EXHIBITS AN OPEN CIRCUIT VOLTAGE GREATER THAN 600V.**

To measure current, connect the meter in series with the load or circuit under test. Press the BLUE button to toggle between alternating and direct current.

## HOW TO USE THE METER

### Holster and Flex-Stand

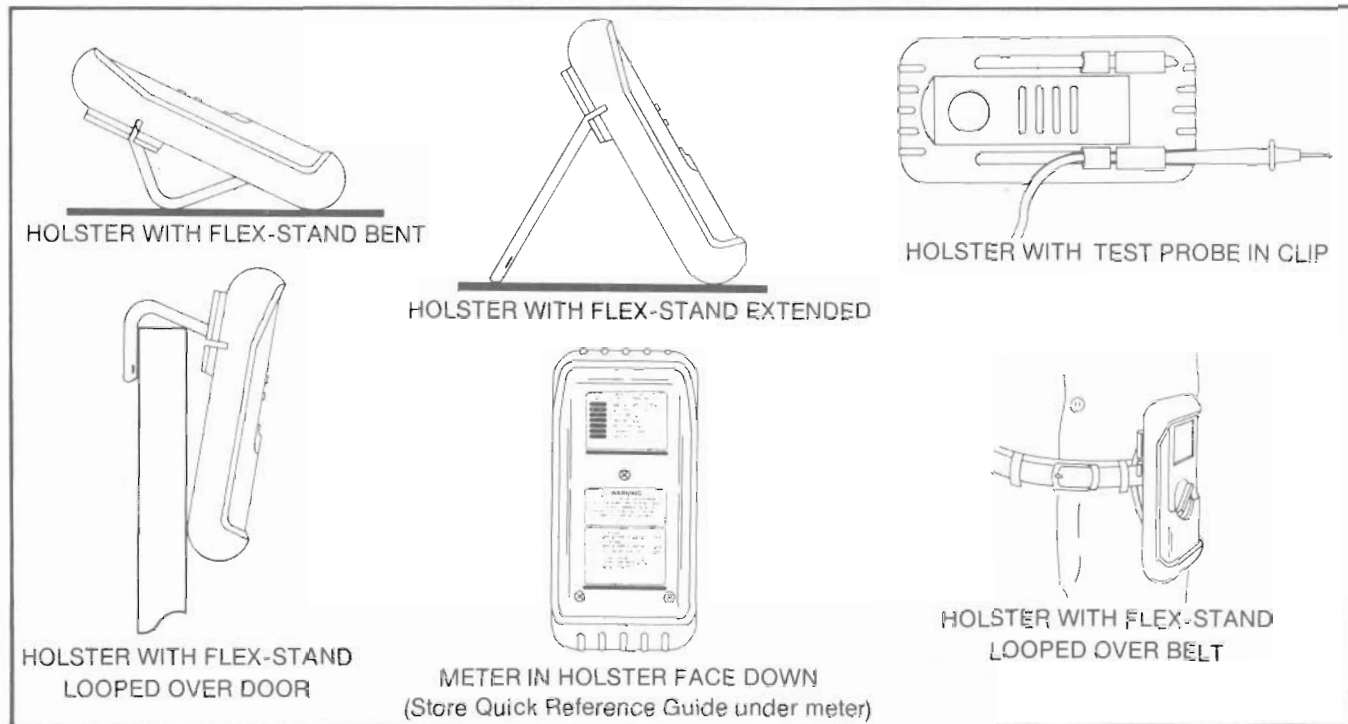

Figure 3. Holster and Flex-Stand





If you do not know approximately what the current is, connect the circuit to the A input terminal first to see if you have a safe level for the mA  $\mu$ A input terminal. Use the mA  $\mu$ A input terminal for current up to 400 mA.

When measuring current, the meter's internal shunt resistors develop a voltage across the meter's terminals called "burden voltage." This voltage drop is very low in your meter, but it may affect precision circuits or measurements.

To calculate the burden voltage: in A, multiply the display reading by 0.03V; in mA, multiply the display reading by 1.5 mV; in  $\mu$ A, multiply the display reading by 100  $\mu$ V. For example, at a 20 mA display reading, the burden voltage is 20.00 x 1.5 mV = 30 mV.

The approximate resistance between the input terminals is 0.03 ohms for A, 1.5 ohms for mA, and 100 ohms for  $\mu$ A.

### Continuity Testing

Continuity testing verifies that circuit connections are intact. To perform audible continuity tests, set the rotary switch to   $\Omega$  , press the  button, and connect the meter to your circuit. Test resistances below the values listed in Table 2 cause the meter to emit a continuous tone. Use the 400 ohm range for most wiring checks.

The continuity mode is extremely fast and can be used to detect either shorts or opens that last for as little as 1 milli-second. When a change is detected, the beeper tone is "stretched" to last at least 1/4 second so you can hear it and detect both shorts and opens. This can be a valuable troubleshooting aid when looking for intermittents associated with cables, connections, switches, relays, etc. If the test value is very close to the threshold, erratic beeps can also occur due to environmental electrical noise (EMI).

### Measuring Resistance

#### CAUTION

**Turn off power on the test circuit and discharge all capacitors before attempting in-circuit resistance measurements. If an external voltage is present across a component, it will be impossible to take an accurate measurement of the resistance of that component.**

The meter measures resistance by passing a known current through the external circuit or component, measuring the voltage drop, and calculating the resistance using Ohm's Law ( $R=V/A$ ). Remember, the resistance displayed by the meter is the total resistance through all possible paths between the probes. This explains why in-circuit measurement of resistors does not often yield the ohms value indicated by the resistor's color code.

## APPLICATIONS

### Measuring Resistance

---

The resistance in the test leads can diminish accuracy on the lowest (400-ohm) range. The error is usually 0.1 to 0.2 ohms for a standard pair of test leads. To determine the error, short the test leads together and read the resistance of the leads. Use the Relative (REL) mode to automatically subtract the lead resistance from resistance measurements.

When measuring resistance, be sure that the contact between the probes and the circuit under test is good. Dirt, oil, solder flux, or other foreign matter seriously affect resistance.

Most in-circuit resistance measurements can be made without removing diodes and transistors from the circuit. The full-scale measurement voltage produced on ranges below 40 M $\Omega$  does not forward-bias silicon diodes or transistor junctions enough to cause them to conduct. Use the highest range you can (except 40 M $\Omega$ ) to minimize the possibility of turning on diodes or transistor junctions. Full-scale measurement voltage in the 40-M $\Omega$  range does forward-bias a diode or transistor enough to cause it to conduct.

In resistance (and all other functions except current), the mA  $\mu$ A input is connected to a 1-kilohm resistor. If the mA  $\mu$ A input protection fuse is good, this input can be used as a partial check of proper operation in resistance. The input

receptacles have split contacts; touch the probe to the half nearest the LCD. The 1-kilohm resistor is protected by a 3-diode clamp. Do not apply external voltage; it may blow the fuse.

### Using Conductance for High Resistance or Leakage Tests

Conductance is the inverse of resistance (i.e., 1 / ohms) and is measured in units of nanosiemens (nS =  $1 \times 10^{-9}$  Siemens). The 40-nS range on your meter effectively extends the resistance measurement capability to 100,000 M $\Omega$ . The 40-nS range can, therefore, be used to test the resistance or leakage in insulators, diodes, transistors, cables, connectors, printed circuit boards, transformers, motors, capacitors, or other high resistance components.

To measure conductance, set the rotary switch to  $\Omega \rightarrow$ , and press **RANGE** to manually increment to the 40-nS range. Plug the test leads into the V $\Omega \rightarrow$  and COM input terminals, and then connect these leads across the unit under test. The reading displayed is in units of conductance (nS). To convert this reading to megohms, divide the reading into 1000 (1000/displayed reading in nS = M $\Omega$ ). For example 2.00 nS converts to 500 M $\Omega$  (1000/2.00). High value resistance measurements are susceptible to induced noise and may require careful shielding. To smooth out most noisy readings, enter the MIN MAX Recording mode and scroll to the average (AVG) reading.

**NOTE**

*In the conductance range, there is normally a small residual reading with open test leads. To ensure accurate measurements, connect clean test leads to the meter and (with the leads open) read the residual leakage in nanosiemens. Correct subsequent measurements by using the Relative mode (REL) to zero the display, which subtracts the residual from the readings.*

Diode leakage tests require that the diode junction be reverse-biased when being measured. To do this, connect the anode of the diode to the COM input terminal and the cathode (ring) of the diode to the  $V\Omega\rightarrow$  input terminal. Leakage at the test voltage being applied can then be read in terms of conductance.

High-voltage, stacked diode, assemblies can usually be tested for forward and reverse resistance changes using conductance. These assemblies typically have such high forward voltage drops that the diode test or resistance modes cannot test them.

**Noisy Resistance Measurements**

Your Fluke meter is designed to tolerate up to several volts of ac noise. Noise appears as changing numbers on the digital display and as an oscillating analog display. Changing the

range may reduce the noise. To smooth out the effect of noise on your readings, enter the MIN MAX Recording mode and scroll to the average reading.

**Measuring Capacitance**

**CAUTION**

**Turn off power and discharge the capacitor before attempting a capacitance measurement. Use the ( $\bar{V}$ ) function to confirm that the capacitor is discharged.**

The meter measures capacitance by charging the capacitor with a known current, measuring the resultant voltage, and calculating the capacitance. The measurement takes about 1 second per range (push button responses also take about 1 second). The capacitor charge can be up to 1.2V.

For measuring capacitor values up to  $5.8\mu\text{F}$ , turn the rotary switch to  $\Omega\rightarrow$ , press the BLUE button, and connect the test leads to the capacitor. The meter will select the proper range automatically. Each measurement takes about 1 second per range. When making repeated measurements of similar values, press **RANGE** to manually select the proper range and to speed up subsequent measurements. For capacitors less than 5 nF or in noisy environments, use short test leads or a test fixture (1 nF = 1000 pF).

## APPLICATIONS

### Diode Testing

The measurement accuracy of capacitors less than 5 nF can be improved by first using the Relative mode to zero the display and automatically subtract the residual meter and test lead capacitance. Since the Relative mode also selects manual ranging, zero the residual capacitance only when measuring small value capacitors.

Residual voltage charges on the capacitor, or capacitors with poor insulation resistance or poor dielectric absorption may cause measurement errors.

To check capacitors larger than 5  $\mu\text{F}$ , select  $\Omega$  with the rotary switch (or press the BLUE button if you are in the capacitance mode). Select an appropriate range from Table 4. Discharge the capacitor, connect the capacitor to the meter, and time the number of seconds it takes for the charge to go from zero to full scale. At full scale, all of the analog display segments are on. To estimate the value of the capacitor, multiply the number of seconds times the charge rate ( $\mu\text{F}/\text{sec}$ ) in Table 4. For example, a 10  $\mu\text{F}$  capacitor takes about 33 seconds to charge in the 4 M $\Omega$  range or 3.3 seconds in the 400 k $\Omega$  range. To reconfirm your estimate, reverse the test leads; when the capacitor discharges to zero (the analog display polarity switches from - to +), start timing the recharge to full scale.

### Diode Testing

To perform a diode or transistor junction test: plug the test leads into the  $V\Omega \rightarrow$  and COM inputs, turn the rotary switch to  $\rightarrow$ , and connect the test leads across the diode(s).

In diode test, voltage is developed across the component(s) by a test current (approximately 1 mA with the test leads shorted) from the meter. Voltage is read on a single 0 to +3.000V range that can measure up to five silicon diode or transistor junctions in series. For a silicon diode, the typical forward voltage should be about 0.6V. Voltages greater than 3.00V or open test leads produce an overload (OL) reading. If the digital reading is the same in both directions, the diode junction is probably shorted. If the display reads OL in both directions, the diode junction is probably open. To protect sensitive devices, the open test lead voltage from the meter will not exceed 3.9V. Negative inputs (from an external power source, for example) are not suppressed.

Table 4. Approximate Charge Rate for Capacitors

Range	400 $\Omega$	4 k $\Omega$	40 k $\Omega$	400 k $\Omega$	4 M $\Omega$
$\mu\text{F}/\text{sec}$	3000	300	30	3	0.3

Use the Touch Hold mode (see item 10) to make audible diode tests. When the test leads are placed across the diode, a good diode or transistor junction will cause the meter to beep (and update the display) in the forward-biased direction and remain silent in the reverse-biased direction. A short or resistance below about 4000 ohms will cause a beep in both directions. If an open is detected, the meter will remain silent in both directions.

### **Using the Analog Display**

The analog display is easy to use and interpret. It functions much the same as the needle on an analog meter without the mechanical overshoot inherent in needle movements.

The analog display is especially useful for peaking and nulling, and observing rapidly changing inputs. The analog display response time is fast, and it can be used to make approximate adjustments quickly. The 4000-count digital display can then be used for final adjustment.

The analog display can also be used for limited diagnostic purposes. In situations where rapidly fluctuating signal levels make the digital display useless, the analog display is ideal. Like the needle on a Volt-ohm-milliammeter (VOM), the analog display excels at displaying trends, or slowly changing signals. Many diagnostic routines using the analog display require practice. You will usually be looking for good or bad signal

patterns that occur over some span of time. Noisy resistance measurements, for instance, create such patterns. Therefore, familiarity with analog display response and movement is necessary to accurately interpret a signal pattern. Compare the analog display response when making measurements on a unit known to be good, to the analog display response when making measurements on a faulty unit.

### **Using the MIN MAX Recording Mode**

The MIN MAX Recording mode can be used to catch intermittents and turn on or turn off surges, verify performance, measure while you are away ("baby sit"), or take readings while you are operating the equipment under test and cannot watch the meter. The audible Min Max Alert indicates when a new minimum or maximum value has been recorded.

You can select either a 100 millisecond, 1 millisecond (Peak), or 1 second (high accuracy) "response time" for recording minimum and maximum readings. The response time is the length of time an input must stay at a new value to record the full change.

The 100 millisecond response time is best for recording power supply surges, inrush currents, and finding intermittent failures. This mode follows the update time of the analog display. (The minimum and maximum excursions of the analog display get recorded.)

## APPLICATIONS

### Measuring Frequency

---

The 1 millisecond Peak MIN MAX mode is ideal for recording transients, especially from intermittent power lines or connections. This mode can also be used to measure the + and - peak values of sinewaves up to about 450 Hz, for easy measurement of both peak line voltage and line current measurements of power supplies and electrical equipment.

The high accuracy mode (1 second response time) follows the digital display and can be selected as a power-on option by pressing **MIN MAX** while turning the meter on. This mode has the full accuracy of the meter and is best for recording power supply drift, line (mains) voltage changes, or circuit performance while line voltage, temperature, load, or some other parameter is being changed. *Frequency Counter readings are recorded only in the high accuracy mode.*

In the MIN MAX Recording mode, the true average of all readings taken since entering MIN MAX is calculated. The average value displayed in both the 100 millisecond and 1 second modes is the mathematical integral of the input (within the response time and accuracy specifications of the meter). When you display the average, the reading rate slows somewhat in order to calculate the average of the accumulated readings.

The average reading is useful for smoothing out unstable or changing inputs, calculating power consumption (such as kilowatt hours), estimating the percent of time a circuit is operational, or verifying circuit performance (or temperature with the optional 80TK Thermocouple Module).

If you want to record readings only during the duration of a particular test (such as during the frequency response sweep of an audio amplifier, for example), apply the input signal, start the test (or sweep, in this example), and let the meter stabilize. Now press **MIN MAX**, then press **HOLD**, and stop the test. The minimum, maximum, and average of all readings taken during the test are now held in memory. Momentarily press **MIN MAX** to scroll to the reading of interest. Be careful: if you hold down the **MIN MAX** for longer than a second, you will exit the MIN MAX Recording mode and erase the memory. As long as the rotary switch is not turned and the other pushbuttons (except REL) are not pressed, these readings will remain in memory until the battery dies.

### Measuring Frequency

In the Frequency Counter mode, the frequency display auto-ranges to one of five ranges: 199.99 Hz, 1999.9 Hz, 19.999 kHz, 199.99 kHz, and greater than 200 kHz. For frequencies below

10 Hz, the update rate slows and follows the input signal. For frequencies between 0.5 Hz and 0.3 Hz, the display may not be stable. For frequencies below 0.3 Hz, the display shows 0.000 Hz.

For most frequency measurements, turn the rotary switch to the  $\bar{V}$  setting, connect the meter to the signal being measured, and then press  $\text{Hz}$  button. Connecting the meter to the signal before pressing Hz will normally allow the meter to autorange to an appropriate range, but the minimum input signal required to trigger the frequency counter varies, depending on the range and frequency (see Specifications). If the input signal is below the trigger level, frequency measurements will not be taken. If your readings are unstable, the input signal may be near the trigger level for that range. You can usually correct this by selecting a lower range. In the Frequency Counter mode, the range (displayed in the lower-right corner of the LCD) will only change when you press the  $\text{RANGE}$  button.

If your readings seem to be a multiple of what you expected, your input signal may have distortion or ringing. (For example, electronic motor controls distort both voltage and current waveforms.) Select a higher input range if you suspect multiple triggering. An alternative is to turn the rotary switch to the  $\bar{V}$  or  $\bar{mV}$  setting, which will shift the trigger level from 0V to a positive voltage that changes with each range. In general, the lowest frequency displayed is the correct one.

In the Frequency Counter mode, the input range acts like an attenuator, the  $\bar{V}$  function ac-couples the input signal, and the  $\bar{V}$  and  $\bar{mV}$  functions dc-couple the input signal. The  $\bar{V}$  function is optimized for triggering on logic and switching signals. The 4V dc range is optimized to trigger on all common 5V logic families (triggers at  $1.7V \pm 0.1V$ ). High frequency logic signals may require the use of the 400 mV ac range. The 40V dc range is optimized to trigger on automotive switching signals (triggers at  $4V \pm 1V$ ). All ranges in the  $\bar{V}$  function trigger at approximately 10% of range, except for the 4V range.

Frequency measurements can be made on current inputs. The inputs are always dc-coupled. The triggering characteristics are shown in Table 5.

**Table 5. Frequency Counter Operation With Current Inputs**

INPUT RANGE	APPROXIMATE SENSITIVITY (0.5 Hz-20 kHz)	APPROXIMATE TRIGGER LEVEL	
		AC CURRENT	DC CURRENT
$\mu A$	300 $\mu A$	0 $\mu A$	400 $\mu A$
mA	30 mA	0 mA	40 mA
A	3A	0A	4A

## APPLICATIONS

### Measuring Duty Cycle

#### Measuring Duty Cycle

Duty Cycle (or duty factor) is an alternate Frequency Counter mode that displays, in percent, the time the input signal is above the trigger level (or below the trigger level if the negative trigger slope is selected). The Duty Cycle mode is optimized for measuring the on or off time of logic or switching controls. Many industrial control systems (electronic fuel injection in automobiles, for example) are pulse-width modulated, and duty cycle measurements provide a quick check on their performance.

For logic level signals, use the 4V dc range. For 12V switching signals in automobiles, use the 40V dc range. For sine waves,

use the most sensitive range you can without getting double triggering. (Normally, a clean signal can be up to ten times the amplitude of the range you are on.) Duty cycle measurements can also be used as an indication of potential triggering problems on sine wave or near sine wave signals. If you do not measure approximately 50% duty cycle, you may have a distorted waveform.

In Duty Cycle (and Frequency Counter) mode, the slope (or edge) on which the counter triggers is selected by pressing . The slope selected is indicated by a + or - annunciator in the lower-left corner of the LCD. The waveform shown in Figure 4 represents the duty cycle measurement of a typical logic signal.

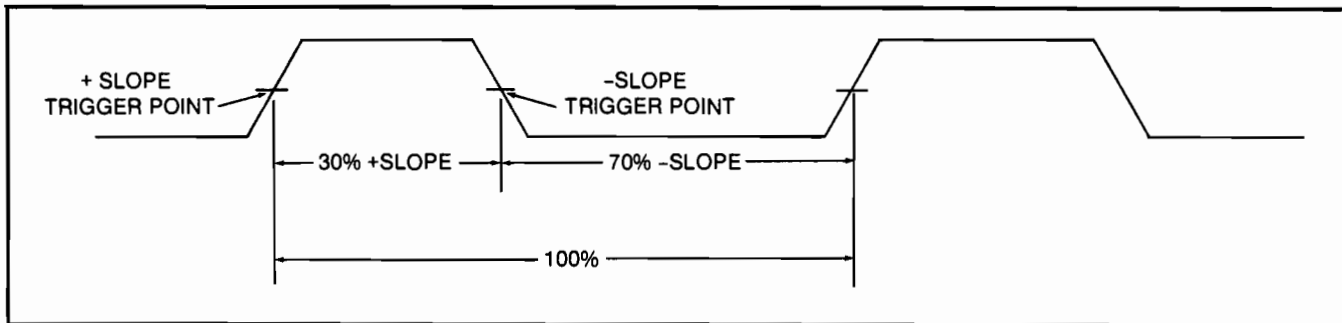

Figure 4. Duty Cycle Measurement of Typical Logic Signal



The manner in which your meter takes duty cycle measurements allows it to be very tolerant of aperiodic (repetitive but not periodic) signals. Duty cycle measurements on low frequency (<400 kHz) aperiodic logic signals, especially serial communication signals, is a simple form of signature analysis. A known pattern will read the same duty cycle every time (if the pattern repeats in less than 1/3 second).

The precision and resolution of the duty cycle measurements are achieved by averaging many repetitions of the input signal. In rare cases, this averaging technique (which is similar to pulse-width averaging in a conventional counter) may cause a measurement problem called "aliasing." Aliasing results when the frequency of the input signal happens to be exactly synchronized with the reference crystal oscillator of the meter. This occurs when the frequency of the input signal can be exactly divided into the frequency of the oscillator (131,072 Hz) or one of the oscillator's harmonics. When they are nearly synchronized, the meter is "blind" to the correct duty cycle, and the display will alternate between incorrect readings. If this occurs, and the frequency reading was stable, press **MIN MAX** to select the MIN MAX Record mode and scroll to the average display. The average display will stabilize on the correct duty cycle.

A common duty cycle measurement is the "dwell" angle in an automobile. Dwell is the number of degrees of distributor rotation that the points remain closed (or current is flowing in the

coil). Use the following to convert a dwell angle to duty cycle (in percent):

$$\% \text{ Duty Cycle} = \frac{\text{Dwell (degrees)} \times \text{No. of Cylinders} \times 100}{360 \text{ degrees}}$$

To make a dwell measurement, set the rotary switch to  $\overline{V}$ , select the 40V range, press **Hz** twice (the % annunciator on the right side of the LCD should turn on), and press the **||||** (to select the negative trigger slope so the measurement will be the "off" or points closed time). Then connect the COM input to ground, and connect the  $V\Omega \rightarrow$  input to the low (or switched) side of the coil. Most automobiles have the points closed for a duty cycle between 50-70%.

### Pulse Width Measurements

For a periodic waveform (that is, repetitive at equal time intervals), a duty cycle measurement can be easily converted to pulse width. First measure the frequency and then measure the duty cycle. Toggle **||||** to select the polarity of the pulse you want to measure. To convert frequency and duty cycle measurements into a pulse width, use the following:

$$\text{Pulse Width} = \frac{\% \text{ Duty Cycle} / 100}{\text{Frequency}}$$

## MAINTENANCE

---

### MAINTENANCE

Repairs or servicing not covered in this manual should only be performed by qualified personnel as described in the 80 Series Service Manual (P/N 834168).

#### General Maintenance

Periodically wipe the case with a damp cloth and detergent (do not use abrasives or solvents). If the input alert is falsely activated by moisture:

1. Turn the multimeter off and remove all test leads.
2. Shake out the input receptacles.
3. Use a clean swab in each of the four terminals to dislodge and clean out the contamination.
4. Soak a new swab with the cleaning and oiling agent WD40. Work this swab around in the A and mA  $\mu$ A terminals. Since the oiling agent insulates the terminals from moisture-related shorting, this preventive treatment ensures against future erroneous Input Alerts.

#### Calibration

Calibrate your meter once a year to ensure that it performs according to its specifications. Contact the nearest Service

Center or refer to the 80 Series Service Manual for calibration procedures. For replacement parts, see the parts list at the end of this manual.

#### WARNING

**TO AVOID ELECTRICAL SHOCK, REMOVE THE TEST LEADS AND ANY INPUT SIGNALS BEFORE REPLACING THE BATTERY OR FUSES. TO PREVENT DAMAGE OR INJURY, INSTALL ONLY QUICK ACTING FUSES WITH THE AMP/VOLT RATINGS SHOWN IN FIGURE 5.**

#### Battery Replacement

The meter is powered by a single 9V battery (NEDA 1604, 6F22, or 006P). Referring to Figure 5, use the following procedure to replace the battery:

1. Disconnect test leads from any live source, turn the rotary switch to OFF, and remove the test leads from the front terminals.
2. The case bottom is secured to the case top by three screws and two internal snaps (at the LCD end). Using a Phillips-head screwdriver, remove the three screws from the case bottom and turn the case over.

**MAINTENANCE**  
**Battery Replacement**

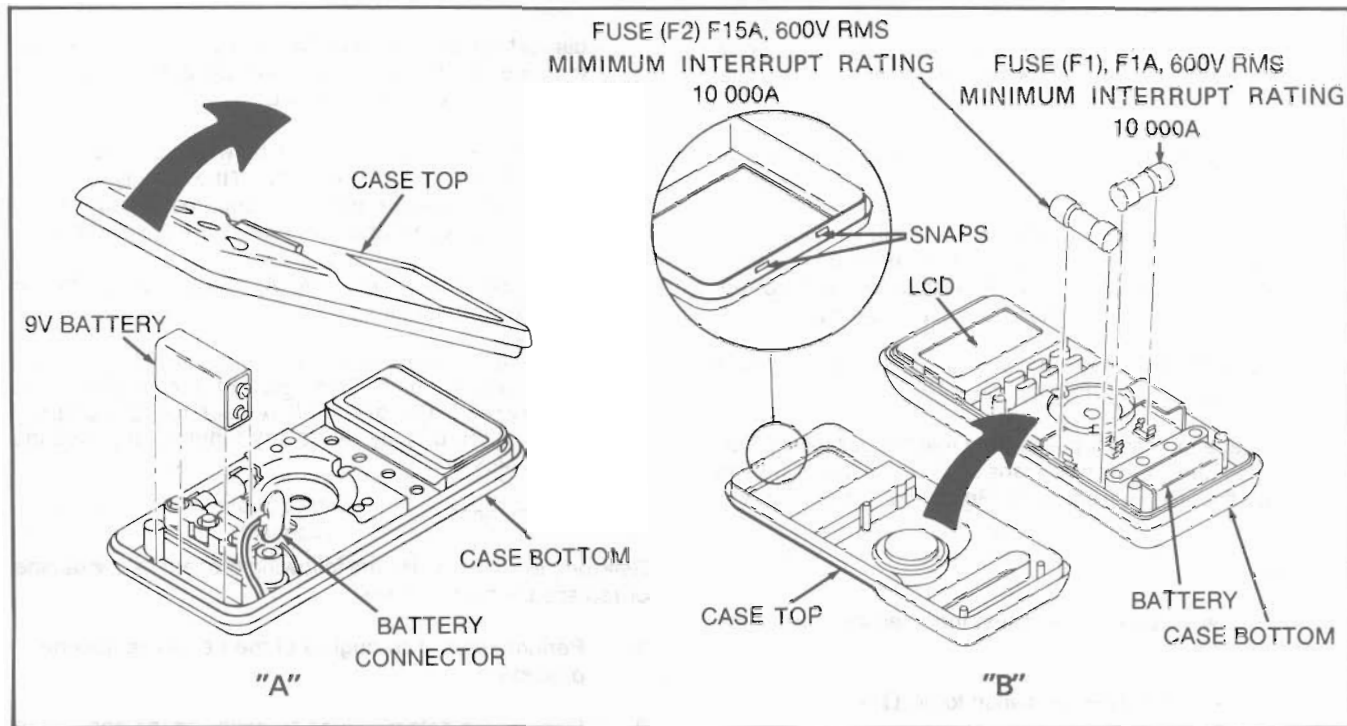

**Figure 5. Battery and Fuse Replacement**

## MAINTENANCE

### Fuse Test and Replacement

---

3. Lift the input terminal end of the case top until it gently unsnaps from the case bottom at the end nearest the LCD.
4. Lift the battery from the case bottom, and carefully disconnect the battery connector leads.
5. Snap the battery connector leads to the terminals of a new battery and reinsert the battery into the case bottom. Dress the battery leads so that they will not be pinched between the case bottom and case top.
6. Ensure that the case top rotary switch and circuit board switch are in the OFF position.
7. Replace the case top, ensuring that the gasket is properly seated and the two snaps on the case top (at the end near the LCD) are engaged. Reinstall the three screws.

#### Fuse Test

Use the following procedure to test the internal fuses of the meter.

1. Turn the rotary selector switch to  $\Omega$ .
2. Plug a test lead into the  $V\Omega$  input terminal and touch the probe to the A input terminal. Because the recepta-

cles of the input terminals contain split contacts, be sure that you touch the probe to the half of the receptacle contact that is nearest the LCD.

3. The display should indicate between 00.0 and 00.5 ohms. This tests F2 (15A, 600V). If the display reads OL (overload), replace the fuse and test again. If the display reads any other value, have the meter serviced.
4. Move the probe from the A input terminal to the mA  $\mu$ A input terminal.
5. The display should indicate between 0.995 kilohms and 1.005 kilohms. This tests F1 (1A, 600V). If the display reads OL (overload), replace the fuse and test again. If the display reads any other value, have the meter serviced.

#### Fuse Replacement

Referring to Figure 5, use the following procedure to examine or replace the meter's fuses:

1. Perform steps 1 through 3 of the battery replacement procedure.
2. Remove the defective fuse by gently prying one end of the fuse loose and sliding the fuse out of the fuse bracket.

3. Install a new fuse of the same size and rating. Make sure the new fuse is centered in the fuse holder.
4. Ensure that the case top rotary switch and circuit board switch are in the OFF position.
5. Replace the case top, ensuring that the gasket is properly seated, the battery leads are properly dressed, and the two snaps on the case top (at the end near the LCD) are engaged. Reinstall the three screws.



### **Service**

If the meter fails, check the battery and fuse(s) and replace as needed. If the meter still does not work properly, review this manual to make sure you are operating it correctly. If the meter still malfunctions, pack it securely in its original shipping container and forward it, postage paid, to the nearest Service Center. Include a description of the malfunction. Fluke assumes NO responsibility for damage in transit.

A meter under warranty will be promptly repaired or replaced (at Fluke's option) and returned at no charge. See the registration card for warranty terms. If the warranty has lapsed, the meter will be repaired and returned for a fixed fee. Contact the nearest Service Center for information and prices. A list of U.S. and international service centers is at the back of this manual.

### **REPLACEMENT PARTS**

#### *NOTE*

  *When servicing the meter, use only the replacement parts specified.*

Replacement parts are shown in Figure 6 and listed in Table 6. To order replacement parts in the USA, call 1-800-526-4731. To order outside the USA, contact the nearest Service Center.

## REPLACEMENT PARTS

Table 6. Replacement Parts

ITEM	DESCRIPTION	FLUKE PART NUMBER	QUANTITY
BT1	Battery, 9V	614487	1
F1*	Fuse, F1A, 600V RMS	830828	1
F2	Fuse, F15A, 600V RMS	820829	1
H1	Screw, Case	832246	3
H2	Gasket, Case	826198	1
MP1	Foot, Non-Skid	824466	2
MP2	O-Ring, Input Receptacle	831933	1
TM1	User's Manual, Fluke 87 (English)	834192	1
TM2	User's Manual, Fluke 87 (International)	834200	—
TM3	Service Manual, Fluke 80 Series	834168	—
TM4	Quick Reference Guide, Fluke 80 Series	844290	1
TL20**	Industrial Test Lead Set (Optional)		—
TL70**	Test Lead Set		1
C81Y**	Holster, Yellow		1
C81G**	Holster, Gray (Optional)		—
C25**	Carrying Case, Soft (Optional)		—

\* To ensure safety, use Bussman BBS-1 or Fluke 830828 only.

\*\* Items marked with two asterisks are Fluke accessories and are available from your authorized Fluke/Philips distributor.

## REPLACEMENT PARTS

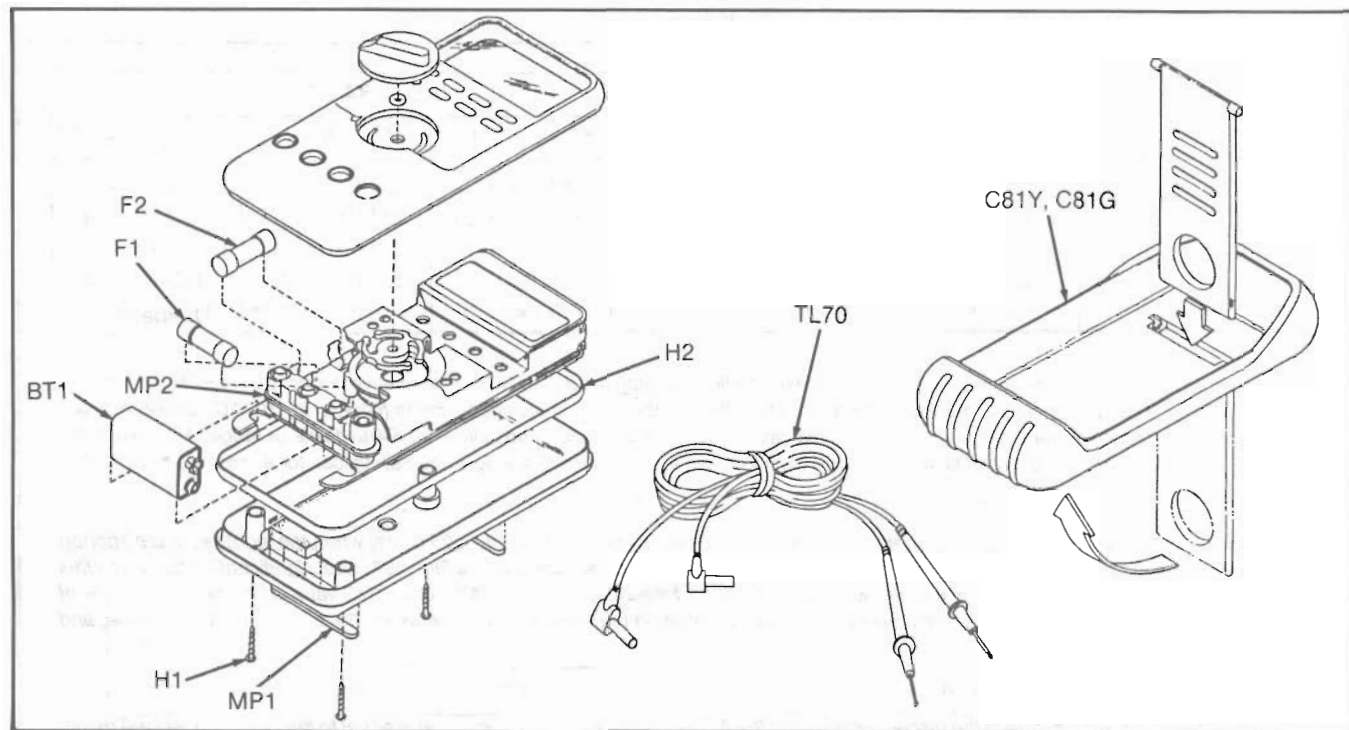

Figure 6. Replaceable Parts

## SPECIFICATIONS

### Specifications

FUNCTION	RANGE	RESOLUTION	ACCURACY*		
			50 Hz-60 Hz	45 Hz-5 kHz	5 kHz-20 kHz**
$\tilde{V}$ †	400.0 mV	0.1 mV	±(0.7% + 4)	±(1.0% + 4)	±(2.0% + 4)
	4.000V	0.001V	±(0.7% + 2)	±(1.0% + 4)	±(2.0% + 4)
	40.00V	0.01V	±(0.7% + 2)	±(1.0% + 4)	±(2.0% + 4)
	400.0V	0.1V	±(0.7% + 2)	±(1.0% + 4)	±(2.0% + 4)
	1000V	1V	±(0.7% + 2)	±(1.0% + 4)**	Unspecified

\* Accuracy is given as  $\pm$  [(% of reading) + (number of least significant digits)] at 18°C to 28°C, with relative humidity up to 90%, for a period of one year after calibration. In the 4 1/2-digit mode, multiply the number of least significant digits (counts) by 10. AC conversions are ac-coupled, true rms responding, calibrated to the rms value of a sine wave input, and valid from 5% to 100% of range. AC crest factor can be up to 3 at full scale, 6 at half scale. For non-sinusoidal wave forms add  $-(2\% \text{ Rdg} + 2\% \text{ Fs})$  typical, for a crest factor up to 3.

\*\* Below 10% of range, add 16 counts.

† The Fluke 87 is a True-RMS responding meter. The meter will display a reading (typically < 25 digits) when the input leads are shorted together in the AC functions which is caused by internal amplifier noise. The accuracy of the Fluke 87 is not significantly affected by this internal offset when measuring inputs that are within 5% to 100% of the selected range. When the RMS value of the two values (5% of range and internal offset) is calculated, the effect is minimal as shown in the following example where 20.0 = 5% of 400 mV range, and 2.5 is the internal offset:

$$\text{RMS} = \text{SQRT}[(20.0)^2 + (2.5)^2] = 20.16$$

If you use the REL function to zero the display when using the AC functions, a constant error that is equal to the internal offset will result.



## Specifications (cont)

FUNCTION	RANGE	RESOLUTION	ACCURACY*
$\overline{\text{V}}$	4.000V	0.001V	$\pm(0.1\% + 1)$
	40.00V	0.01V	$\pm(0.1\% + 1)$
	400.0V	0.1V	$\pm(0.1\% + 1)$
	1000V	1V	$\pm(0.1\% + 1)$
$\overline{\text{mV}}$	400.0 mV	0.1 mV	$\pm(0.1\% + 1)$
$\Omega$  (nS)	400.0 $\Omega$	0.1 $\Omega$	$\pm(0.2\% + 1)$
	4.000 k $\Omega$	0.001 k $\Omega$	$\pm(0.2\% + 1)$
	40.00 k $\Omega$	0.01 k $\Omega$	$\pm(0.2\% + 1)$
	400.0 k $\Omega$	0.1 k $\Omega$	$\pm(0.2\% + 1)$
	4.000 M $\Omega$	0.001 M $\Omega$	$\pm(0.2\% + 1)$
	40.00 M $\Omega$	0.01 M $\Omega$	$\pm(1\% + 3)$
	40.00 nS	0.01 nS	$\pm(1\% + 10)$

## TYPICAL OHMS SHORT CIRCUIT CURRENT

RANGE	400	4k	40k	400k	4M	40M
CURRENT	700 $\mu\text{A}$	170 $\mu\text{A}$	20 $\mu\text{A}$	2 $\mu\text{A}$	.2 $\mu\text{A}$	.2 $\mu\text{A}$

## SPECIFICATIONS

### Specifications (cont)

FUNCTION	RANGE	RESOLUTION	ACCURACY***
Capacitance	5.00 nF	0.01 nF	+/- (1% + 3)
	0.0500 $\mu$ F	0.0001 $\mu$ F	+/- (1% + 3)
	0.500 $\mu$ F	0.001 $\mu$ F	+/- (1% + 3)
	5.00 $\mu$ F	0.01 $\mu$ F	+/- (1% + 3)
Diode Test	3.000V	0.001V	$\pm$ (2% + 1)

FUNCTION	RANGE	RESOLUTION	ACCURACY*	MAXIMUM BURDEN VOLTAGE
mA A ~ †	40.00 mA	0.01 mA	$\pm$ (1.0% + 2)	1.5 mV/mA
	400.0 mA	0.1 mA	$\pm$ (1.0% + 2)	1.5 mV/mA
	4000 mA	1 mA	$\pm$ (1.0% + 2)	0.03 V/A
	10.00A††	0.01A	$\pm$ (1.0% + 2)	0.03 V/A
mA A ≡	40.00 mA	0.01 mA	$\pm$ (0.2% + 2)	1.5 mV/mA
	400.0 mA	0.1 mA	$\pm$ (0.2% + 2)	1.5 mV/mA
	4000 mA	1 mA	$\pm$ (0.2% + 2)	0.03 V/A
	10.00A††	0.01A	$\pm$ (0.2% + 2)	0.03 V/A

\*\*\* With film capacitor or better, using Relative mode to zero residual.

† See page 34 for a complete explanation of this notation.

†† 10A continuous, 20A for 30 seconds maximum

## Specifications (cont)

FUNCTION	RANGE	RESOLUTION	ACCURACY	MAXIMUM BURDEN VOLTAGE
$\tilde{\mu A}$ † (45 Hz to 2 kHz)	400.0 $\mu A$	0.1 $\mu A$	$\pm(1.0\% + 2)$	100 $\mu V / \mu A$
	4000 $\mu A$	1 $\mu A$	$\pm(1.0\% + 2)$	100 $\mu V / \mu A$
$\overline{\mu A}$	400.0 $\mu A$	0.1 $\mu A$	$\pm(0.2\% + 2)$	100 $\mu V / \mu A$
	4000 $\mu A$	1 $\mu A$	$\pm(0.2\% + 2)$	100 $\mu V / \mu A$

FUNCTION	RANGE	RESOLUTION	ACCURACY
Frequency (0.5 Hz to 200 kHz, pulse width >2 $\mu s$ )	199.99	0.01 Hz	$\pm(0.005\% + 1)$
	1999.9	0.1 Hz	$\pm(0.005\% + 1)$
	19.999 kHz	0.001 kHz	$\pm(0.005\% + 1)$
	199.99 kHz	0.01 kHz	$\pm(0.005\% + 1)$
	>200 kHz	0.1 kHz	Unspecified

† See page 34 for a complete explanation of this notation.

## SPECIFICATIONS

### Specifications (cont)

FREQUENCY COUNTER SENSITIVITY AND TRIGGER LEVEL			
INPUT RANGE	MINIMUM SENSITIVITY (RMS SINEWAVE)		APPROXIMATE TRIGGER LEVEL (DC VOLTAGE FUNCTION)
	5 Hz-20 kHz	0.5 Hz-200 kHz	
(Maximum input for specified accuracy = 10X Range or 1000V)			
400 mV dc	70 mV (to 400 Hz)	70 mV (to 400 Hz)	40 mV
400 mV ac	150 mV	150 mV	—
4V	0.3V	0.7V	1.7V
40V	3V	7V	4V
400V	30V	70V ( $\leq 140$ kHz)	40V
1000V	300V	700V ( $\leq 14$ kHz)	400V
Duty Cycle	0.0 to 99.9%		
	Accuracy:	Within $\pm(0.05\% \text{ per kHz} + 0.1\%)$ of full scale for a 5V logic family input on the 4V dc range.  Within $\pm((0.06 \times \text{Voltage Range}/\text{Input Voltage}) \times 100\%)$ of full scale for sine wave inputs on ac voltage ranges.	

## Specifications (cont)

FUNCTION	OVERLOAD PROTECTION†	INPUT IMPEDANCE (nominal)	COMMON MODE REJECTION RATIO (1 k $\Omega$ unbalance)	NORMAL MODE REJECTION	
$\overline{\text{V}}$	1000V rms	10 M $\Omega$ <100 pF	>120 dB at dc, 50 Hz or 60 Hz	>60 dB at 50 Hz or 60 Hz	
$\overline{\text{mV}}$	1000V rms	10 M $\Omega$ <100 pF	>120 dB at dc, 50 Hz or 60 Hz	>60 dB at 50 Hz or 60 Hz	
$\sim\text{V}$	1000V rms	10 M $\Omega$ <100 pF (ac-coupled)	>60 dB, dc to 60 Hz		
$\Omega$	1000V rms ††	OPEN CIRCUIT TEST VOLTAGE	FULL SCALE VOLTAGE		SHORT CIRCUIT CURRENT
			To 4.0 M $\Omega$	40 M $\Omega$ or nS	
		<1.3V dc	<450 mV dc	<1.3V dc	<700 $\mu\text{A}$
<b>Diode Test</b>	1000V rms ††	<3.9V dc	3.000V dc		1.0 mA typical

† 10<sup>7</sup> V Hz max

†† For circuits &lt; 0.3A short circuit, 660V for high energy circuits.

## SPECIFICATIONS

### Specifications (cont)

MIN MAX Recording	NOMINAL RESPONSE	ACCURACY
	100 ms to 80%	Specified accuracy $\pm 12$ digits for changes $> 200$ ms in duration ( $\pm 40$ digits in AC)
1 s	Same as specified accuracy for changes $> 2$ seconds in duration	
1ms	Specified accuracy $\pm 40$ digits for changes $> 1$ ms in duration. ( $\pm 100$ digits typical for mV, 400 $\mu$ A dc, 40 mA dc, 4000 mA dc).	

FUSE PROTECTION	
mA or $\mu$ A A	1A 600V FAST Fuse 15A 600V FAST Fuse

MAXIMUM VOLTAGE BETWEEN ANY TERMINAL AND EARTH GROUND
1000V rms

## Specifications (cont)

<b>Display</b>	Digital: 4000 counts, updates 4/sec 19,999 counts (4 ½-digit mode), updates 1/sec Analog: 4 x 32 segments (equivalent to 128), updates 40/sec Frequency: 19,999 counts, updates 3/sec @ > 10 Hz Backlight: On for 68 seconds when selected.
<b>Operating Temperature</b>	-20°C to 55°C
<b>Storage Temperature</b>	-40°C to 60°C
<b>Temperature Coefficient</b>	0.05 x (specified accuracy)/°C (<18°C or >28°C)
<b>Relative Humidity</b>	0% to 90% (0°C to 35°C) 0% to 70% (35°C to 55°C)
<b>Battery Type</b>	9V, NEDA 1604 or 6F22 or 006P
<b>Battery Life</b>	400 hrs typical with alkaline
<b>Shock, Vibration</b>	Per MIL-T-28800 for a Class 2 Instrument
<b>Size (HxWxL)</b>	1.25 in x 3.41 in x 7.35 in (3.1 cm x 8.6 cm x 18.6 cm)
<b>With Holster and Flex-Stand:</b>	2.06 in x 3.86 in x 7.93 in (5.2 cm x 9.8 cm x 20.1 cm)
<b>Weight</b>	12.5 oz (355g)
<b>With Holster and Flex-Stand:</b>	22.0 oz (624g)
<b>Safety</b>	Designed to Protection Class II per IEC 348, ISA-DS82, UL1244, and CSA C22.2 No. 231.

## SERVICE CENTERS

### USA

#### California

Fluke Technical Center  
48610 Landing Parkway  
Fremont, CA 94538  
TEL: (415) 861-6112;

Fluke Technical Center  
16715 Von Karman Avenue  
Suite 110  
Irvine, CA 92714  
TEL: (714) 868-9031

#### Florida

Fluke Technical Center  
560 S. North Lake Blvd.  
Altamonte Springs, FL 32701-5227  
TEL: (407) 331-2929  
TLX: (810) 860-0185

#### Illinois

Fluke Technical Center  
1150 W. Euclid Avenue  
Palatine, IL 60067  
TEL: (708) 705-0500  
TLX: (708) 705-0064

#### New Jersey

Fluke Technical Center  
East 66 Midland Avenue  
Paramus, NJ 07652-0930  
TEL: (201) 599-9500

#### Texas

Fluke Technical Center  
2104 Hutton Drive  
Suite 112  
Carrollton, TX 75006  
TEL: (214) 406-1000

#### Washington

Fluke Technical Center  
John Fluke Mfg. Co., Inc.  
M/S 6-30  
Everett WA 98203  
TEL: (206) 356-6560  
TLX: 185249

### INTERNATIONAL

#### Argentina

Coasin S.A.  
Virrey del Pino 4071 DPTO E-66  
1430 CAP FED  
Buenos Aires  
TEL: 54 1 522-5248  
TLX: (390) 22284 COASN AR

#### Australia

Phillips Customer Support  
Scientific and Industrial  
23 Lakeside Drive  
Tully Ho Technology Park  
East Burwood  
Victoria 3151

Phillips Customer Support  
Scientific and Industrial  
25-27 Paul St. North  
North Ryde, N.S.W. 2113  
TEL: 61 2 886-8222  
TLX: (790) AA20166 AUSNRSI+PHILIND

#### Austria

Oesterreichische Phillips Industrie  
Unternehmensbereich Prof. Systeme  
Guthel Schoder  
Gasse 10  
A-1102 Wein  
TEL: 43 222-60101x1388  
TLX: 133129

#### Belgium

Phillips Professional System S.A.  
I & E Division  
Service Department  
80, Rue des Deux Gares  
B-1070 Brussels  
TEL: 32 2 525-6111  
TLX: (846) 61511 BELBRMS

#### Brazil

Hi-Tek Electronica Ltda.  
Al. Amazonas 422, Alphaville  
CEP 06400 Barueri  
Sao Paulo  
TEL: 55 011 421-5477  
TLX: (391) 11 71413 HITK BR

### Canada

Fluke Electronics Canada Inc.  
400 Britannia Road East, Unit #1  
Mississauga, Ontario  
L4Z 1X9  
TEL: 416 890-7600

### Chile

Intronsa Inc.  
Casilla 16228  
Santiago 9  
TEL: 56 2 232-1886, 232-4308  
TLX: (332) 346351 INTRON CK

### China

Fluke Service Center  
Room 2111 Scite Tower  
Jiangumenwai Dajie  
Beijing 100004, PRC  
TEL: 86 1 512-3436 or 6351  
TLX: (716) 222529 FLUKE CN

### Colombia

Sistemas E Instrumentacion, Ltda.  
Carrera 21, NO. 38A-21, OF. 101  
Ap. Aereo 29583  
Bogota  
TEL: 57 287-5424

### Costa Rica

Electronic Engineering, S.A.  
Carretera de Circunvalacion  
Sabanita Av. Novena  
San Jose  
TEL: 506-53-3759

### Denmark

Phillips Electronik Systemer A/S  
Strandlodsvej 4B  
DK 2300  
Copenhagen  
TEL: 45 32 882531  
TLX: 31201 phil dk

### Ecuador

Proteco Coasin Cia., Ltda.  
P.O. Box 17-03-228-A  
Ave. 12 de Octubre  
2449 y Orellana  
Quito  
TEL: 593 2 230283 or 520005  
TLX: (383) 22085 PROTECED

### Egypt

Phillips Egypt  
10, Abdel Rahman el Rafei et.  
el. Mohandessin  
P.O. Box 242  
Dokki Cairo  
TEL: 20 2 490922  
TLX: 22816 phegy un

### England

Phillips Scientific  
Test & Measuring Division  
Colonial Way  
Watford  
Hertfordshire WD2 4TT  
TEL: 44 923-240511  
TLX: (851) 934583 PHI TMD

### Federal Republic of Germany

Phillips GmbH  
Service VSF  
Unternehmensbereich Elektronik  
für Wissenschaft und Industrie  
Oskar-Meesterstrasse 18  
D-8045 Ismaning/Munich  
TEL: 49 89 9605

### Finland

Oy Phillips AB  
Central Service  
Sinkkilaentie 1-3  
P.O. Box 11  
02631 ESPOO  
TEL: 358 0 502-8200  
TLX: 121875 fixheps

### France

S.A. Phillips Industrielle et  
Commerciale,  
Science et Industrie  
105 Rue de Paris BP 62  
93002 Bobigny, Cedex  
TEL: 33-1-4942-8040  
TLX: 210230 induphi

### Greece

Phillips S.A. Hellenique  
15,25th March Street  
177 78 Tavros  
10210 Athens  
TEL: 30 1 4894911  
TLX: 241566/241567 Intragra



**Hong Kong**

Schmidt & Co (H.K.) Ltd.  
18/FL., Great Eagle Centre  
23 Harbour Road  
Wanchai  
TEL: 852 507-0222  
TLX: (780) 76782 SCHMC HX

**India**

Hinditron Services Pvt. Inc.  
3344A Raj Mahal Vilas Extension  
8th Main Road  
Bangalore 560 080  
TEL: 91 812 348-266 or 340-066  
TLX: (953) 845271 HSPL IN

Hinditron Services Pvt. Ltd  
1st Floor, 17-B,  
Mahal Industrial Estate  
Mahakali Road, Andheri East  
Bombay 400 093  
TEL: 91 22 6300043  
TLX: (953) 11-79387 HEMC IN

Hinditron Services Pvt. Ltd.  
15 Community Centre  
Panchahala Park  
New Delhi 110 017  
TEL: 91 011 643-3675  
TLX: (953) 031-61458 HCPL IN

Hinditron Services Pvt. Ltd.  
Field Service Center  
Emerald Complex 1-7-264  
5th Floor  
114 Sarojini Devi Road  
Secunderabad 500 003  
TEL: 91 842-844033  
TLX: (953) 425-6973

**Indonesia**

P. T. Daeng Brothers  
Phillips House  
J1. Rasuna Said Kav. 3-4  
Jakarta 12950  
TEL: 82 21 520 1122  
TLX: (792) 62188 PHDC IA

**Israel**

R.D.T Electronics Engineering, Ltd.  
P.O. Box 58013  
Tel Aviv 61580  
TEL: 972-3-5483737  
TLX: (922) 371452 RDT IL

**Italy**

Phillips S.P.A.  
Sezione I&E /T&M  
Viale Elvezia 2  
20052 Monza  
TEL: 39-39-203-6525  
TLX: 333343 philai i

**Japan**

Fluke Corporation  
Sumitomo Higashi Shinbashi Bldg.  
1-1-11 Hamamatsucho  
Minato-ku  
Tokyo 105  
TEL: 81 3 3434-0181  
TLX: (781) 2424331 FLUKJPJ

**Korea**

Myoung Corporation  
Yeo Eui Do P.O. Box 14  
Seoul 150  
TEL: 82 2 784-9942  
TLX: (787) 24283 MYOUNG

**Malaysia**

Mecomb Malaysia Sdn. Bhd.  
P.O. Box 24  
46700 Petaling Jaya  
Selangor  
TEL: 60 3 774-3422  
TLX: (764) MA37764 MECOMB

**Mexico**

Mexel Mexicana De Electronica  
Industrial, S.A. De C.V.  
Calle Diagonal #27 Ser.  
Col. Del Valle  
C.P. 03100, Mexico D.F.  
TEL: 52-5-682-8040  
TLX: 1171038 FAIRME

**Netherlands**

Phillips Nederland  
Dep. Technical Service Prof. Act.  
P.O. Box 218  
Building HBR  
5600 MD Eindhoven  
TEL: 31-40-503110  
TLX: 51238

**New Zealand**

Phillips Customer Support  
Scientific & Industrial  
2 Wagener Place Mt. Albert  
Private Bag, St. Lukes  
Auckland 3  
TEL: 64 9 894-160  
TLX: (791) NZ 2395

**Norway**

Norsk AS Phillips  
I&E Service  
Sandstuveien 70  
Postboks 1 Manglerud  
N 0680 OSLO 6  
TEL: 47-2-748-408  
TLX: 72840 philps n

**Peru**

Importaciones & Representaciones  
Electronicas S.A.  
Aved Franklin D. Roosevelt 105  
Lima 1  
TEL: 51 14 288650  
TLX: (394) 25663 PE IREING

**Philippines**

Spark Electronics Corp.  
P.O. Box 610, Greenhills  
Metro Manila 1502  
TEL: 63 2 700-621  
TLX: (722) 4005 RLA PH PU

**Portugal**

Phillips Portuguese S.A.  
I&E Division  
Ourela 7  
P.O. Box 55  
2795 LINDA-A-VELHA  
TEL: 351 1 4170071  
TLX: 65120 PTLPGAJ

**Republic of South Africa**

South African Phillips (Pty) Ltd.  
I&E Service Mgr.  
P. O. BOX 7703  
Johannesburg 2000  
TEL: 27 11 888-3911  
TLX: (960) 4-26152 SA

**Singapore**

Rank O'Connor's Singapore Pte Ltd  
98 Pasir Panjang Road  
Singapore 0511  
TEL: 65 4737944  
TLX: (786) RS21023 OCONSIN

**Spain**

Phillips Iberica Sae  
Depto. Tecnico Instrumentacion  
c/Martinez Villergas 2  
28027 Madrid  
TEL: 34 1 4042314  
TLX: 052-27710 dsxma eesm/op

**Sweden**

Phillips Kjetaindustrier AB  
I&E Technical Customer Support  
Borgerforjdegatan 16  
S 184 93 Kista  
TEL: 46-8-782-1300  
TLX: 854 17173 PHILKJ S

**Switzerland**

Phillips Industrial Electronics  
Test and Messtechnik  
Riedstrasse 12  
Postfach 360  
CH-8953 Dietikon  
TEL: 41 1 745-2244  
TLX: (845) 8157780-0

**Taiwan, R.O.C.**

Schmidt Electronics Corp.  
5th Floor, Cathay Min Sheng  
Commercial Building,  
344 Min Sheng East Road  
Taipei  
TEL: 886 2 501-3468  
TLX: (785) 11111 SCHMIDT

**Thailand**

Measurtronix Ltd.  
2102/31 Rammikhaeng Road  
Bangkok 10240  
TEL: 66 2 375-2733, 375-2734  
TLX: (788) 82796 HUAMARK TH

**Turkey**

Turk Phillips Ticaret A.S.  
Inonu Caddesi 78/80  
Posta Kutusu 504-Beyoglu  
Istanbul  
TEL: 90 1 1435891  
TLX: 24192 phtr trtrxbph

**Uruguay**

Coasin Uruguaya S.A.  
Casilla de Correo 1400  
Libertad 2525  
Montevideo  
TEL: 598-2-789015  
TLX: (398) COAUR UY23010

**Venezuela**

Coasin C.A.  
Calle 9 Con Calle 4, Edif. Edinurbi  
Apartado de Correos Nr-70-138  
Los Ruices  
Caracas 1070-A  
TEL: 58 2 241-0309, 241-1248  
TLX: (395) 21027 EMVEN VC